

modular/panel-built sauna kit

installation instructions



Please immediately check for any hidden damage that may have occurred in shipping. If any damage is found you must notify the delivering carrier within seven days.

A few minutes with the following instructions will insure quick and proper assembly, and many years of enjoyment and relaxation. By reviewing all the instruction steps ahead of time, you will have a better feel for the whole process.

Your sauna package will arrive on a stretch-wrapped pallet including a stack of pre-built panels, benches, and boxes with the heater and accessories.



Your sauna can be placed on concrete, tile, linoleum, or any surface that does not absorb water. Do not install the sauna on carpeting.

Tools Required

- Hammer or pin nailer
- Handsaw and mitre box (for molding installation & vent holes)
- Drill or cordless screwdriver
- Tape measure
- Square
- Level
- 3/8" wood bit (if sauna room has an L-bench)
- 3/4" wood bit (optional, see photo B2)
- Note: Torx bit is provided

Accessories

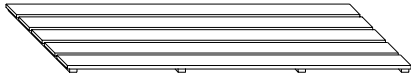

Duckboard

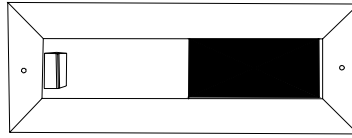

Vent Valve

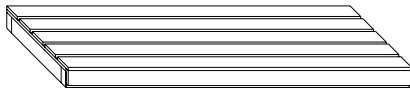

Bench

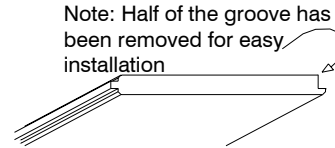

Electrical Access Board

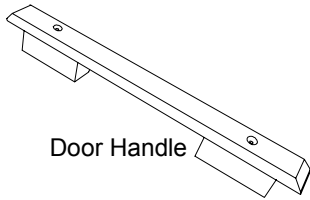

Door Handle

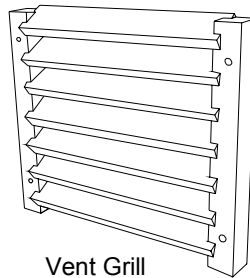

Vent Grill

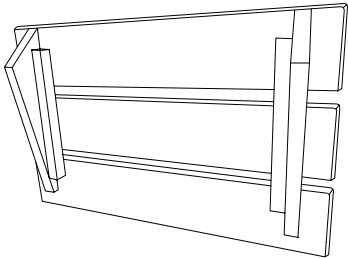

Headrest

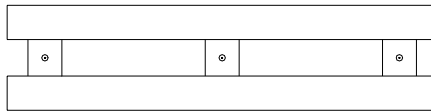

Backrest

Trim Profiles



Cove Molding

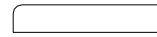

Window/Door Casing
(normally pre-installed)



Inside Corner Molding



Exterior Facia Trim
(in some models)

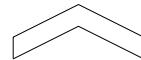

Outer 45 Deg. Corner Molding
(on rooms w/more than 4 walls)

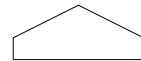

Inside 45 Deg. Corner Molding
(on rooms w/more than 4 walls)

Hardware Package



2" Screws

1-1/2" Screws

Carriage Bolts

(for saunas with L-benches)

Washers & Nuts

Finishing Nails

3" Screws

Torx Bit

Wood Joiners

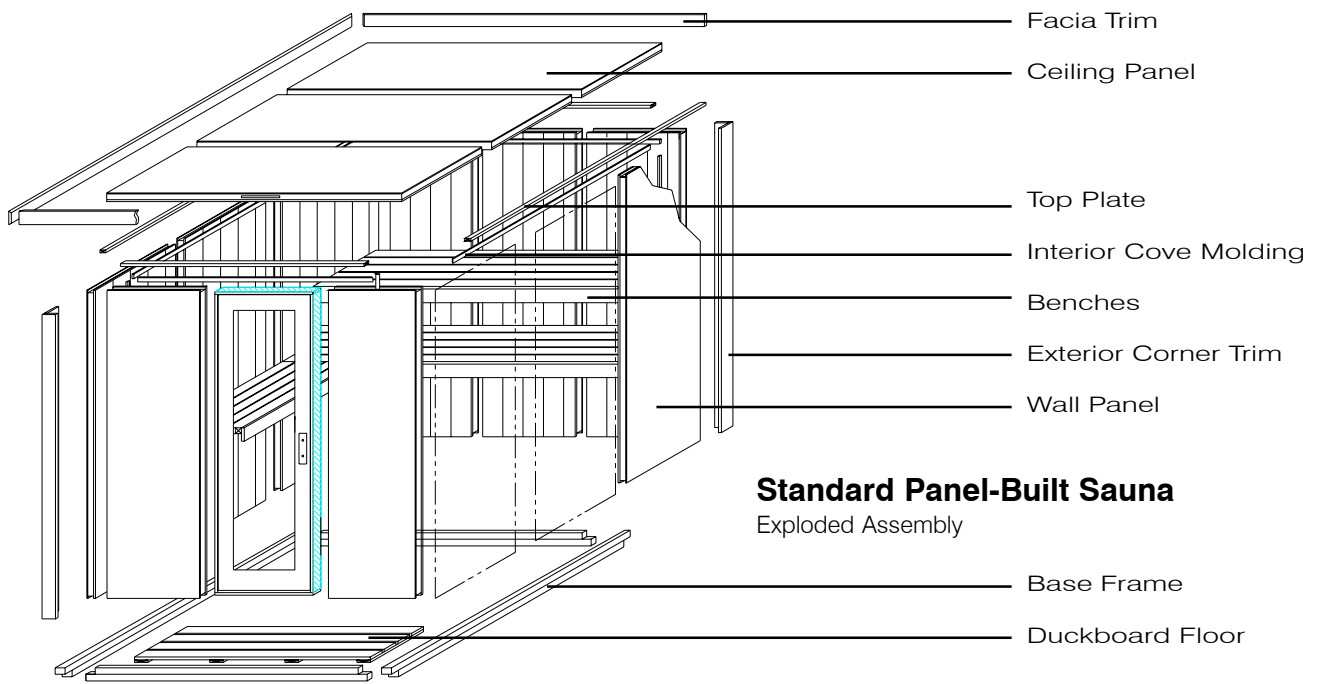

Base Frame Assembly

If the sauna is to be positioned close to a wall or corner, start assembly away from the wall and once the rear panels are installed push the sauna into place.

1 Position the base frame on the floor (photo A). The largest number on the base frame is the standard door location. The stamped numbers on the base frame should be readable from inside of the room and correspond to the wall panels that will be placed on them in a later step.

2 The air inlet should be as near the heater as possible. Using a hand saw or a sabre saw, cut a notch approximately 6 inches long in the bottom half of the base frame (photo B1). Another option is to drill four 3/4" holes in the base frame below the heater (photo B2).

3 Using one three-inch screw at each corner and the pre-drilled holes, fasten the corners of the base frame (photo C).

Note: *The pre-drilled holes are purposely made at an angle.*

4 Using a level and a square, make sure the base frame is square and level. Shim it where needed with standard shims.



Wall Panel Installation

If the sauna is to be placed against existing wall(s), panel installation should begin at these sides. After these panels are in place, the sauna can be slid back towards the wall(s) keeping it 1/2" to 1" away.

All wall panels are numbered at the top and should be readable from the interior of the room. These numbers will coincide with the numbers on the base frame. **NOTE:** The tongue and groove on the panels will always face the same direction.



5 Start your wall panel assembly in a corner. **NOTE:** It is not always necessary to install your panels in sequence according to their numbers. Two wall panels make up each corner. Slide one panel along the base frame until its 2x2 framework is flush with the outside of the base frame (diagram A, panel 3).

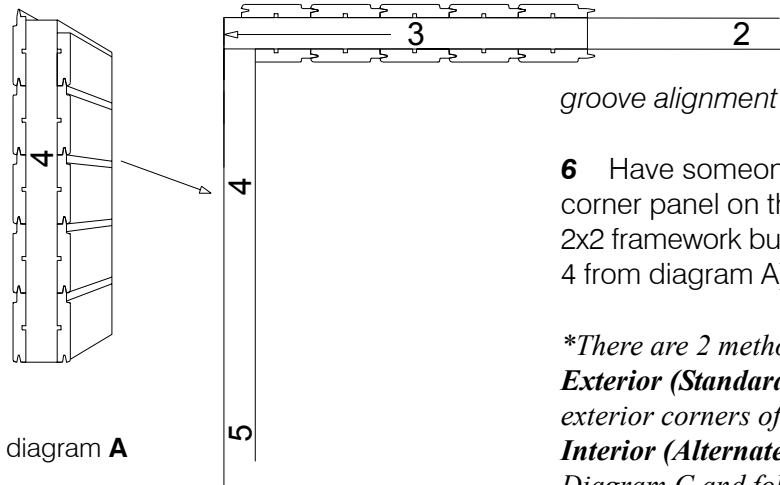

diagram A

NOTE: For ease in installing the panels, tilt the top of each panel back to get the tongue and groove alignment started. Then tilt forward for an easy fit.

6 Have someone hold the first panel in place and then put the other corner panel on the base frame and slide it tight into the corner so its 2x2 framework butts up against the framework of the other panel (panel 4 from diagram A).

*There are 2 methods for fastening your wall panels ...

Exterior (Standard): To be followed when there is easy access to all exterior corners of the sauna. See diagram B and follow steps 7A & 8A.

Interior (Alternate): When room was ordered as "Interior Install". See Diagram C and follow steps 7B & 8B.

7A Fasten the two panels together from the outside of the room using 3" torx screws. Holes are pre-drilled.

8A Install exterior, pre-assembled corner trim with provided #4 finishing nails. (photo E). **NOTE:** One side of the groove has been removed for easy installation.

OR

7B Fasten the two panels together from the inside of the room using 3" torx screws. Angled holes are pre-drilled.

8B Install the removed interior tongue & groove using #4 finishing nails. **NOTE:** If exterior corner is exposed install exterior, pre-assembled corner trim with provided #4 finishing nails. (photo E)

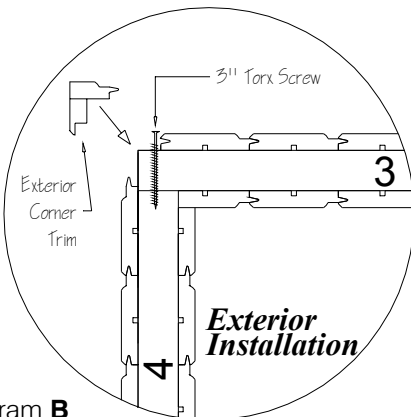

diagram B

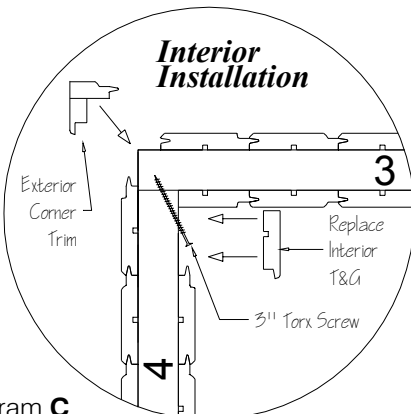

diagram C



9 Continue setting the panels into place as marked. Use the barbed wood fasteners to join the tops of the panels (photo F).

IMPORTANT: If you are in a low ceiling height situation (space above sauna is less than 3"). You must put the top plate and ceiling panels in before installing the front wall panels as described in step 10 method B.

NOTE: The door panel should be installed before your last corner panel is put in place. Use two people to move it as it is quite heavy.

Top Plate Installation

After installing the wall panels, the next step is to assemble and install the top plate (sometimes referred to as the "ceiling frame"). This top plate aligns and locks the top of the wall panels together.

There are 2 methods for fastening your top plate ...

Standard: To be followed when there is easy access to the top of the sauna.

Alternate: To be followed when access to the top of the sauna is limited.

10a (Standard):

In most installations it is easier to install the top plate one piece at a time, rather than pre-assembling it on the floor. To do so, install the sections onto the front and back wall with the notched ends facing up (photo G). Then put the side pieces of the plate into place. Firmly press it down (use a hammer if needed) till it rests on the framework of the wall panels. The top of the plate should be flush with the top of the interior tongue and groove. Fasten with one 2" screw in each corner (photo H).

10b (Alternate):

 (Especially needed for low ceiling heights)

Layout all pieces of your top plate on the floor. Using one 1" screw in each corner, fasten all corners together then drop the top plate into place along the top of the wall panels. Firmly press it down, using a hammer if needed, till it rests on the framework of the wall panels. The top of the plate should be flush with the top of the interior tongue and groove.

11 Install the provided foam tape along top plate to give a better seal once the ceiling panels are installed. Tape should be centered on the top plate and will encircle the entire room.

Ceiling Panel Installation

Low Height Installation Tip: If the clearance above the sauna is less than 3", the ceiling panels should be installed prior to the front wall panels.

12 With one person inside the sauna room and another outside, feed the ceiling panels over the top of the walls being very careful not to scratch the panels (photo I). When in position, they will rest on the top plate.

13 In the case of more than one ceiling panel, adjoin the panels as shown. Lift the panels together, then lower at the same time allowing the tongue and groove to lock together (photo J).

NOTE: In larger saunas, 3 or more ceiling panels may be provided.

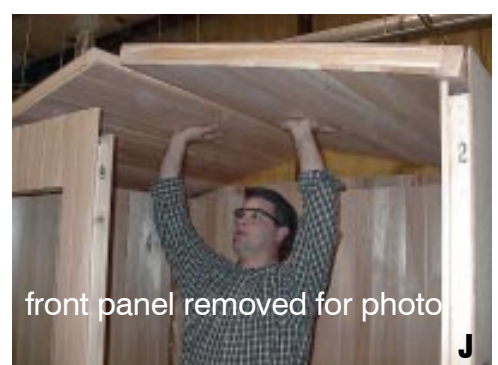
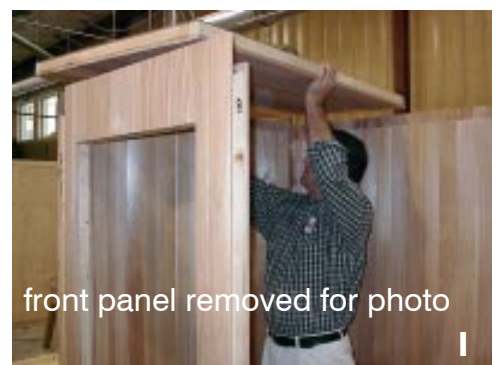
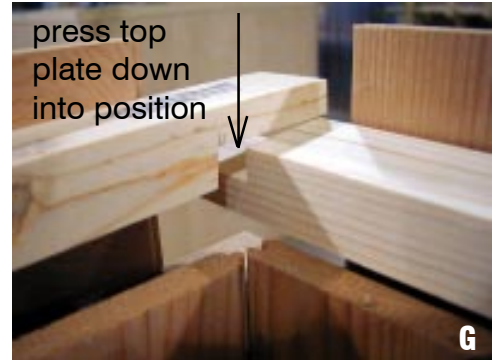



Cove Molding Installation

14 The cove molding (3/4" x 1") will be provided longer than needed to allow trimming to exact size to insure a tight fit. Measure each wall to determine cut length. A simple butt-end cut is the easiest. Cut molding straight, then butt the pieces together (photo K). If you prefer a mitre joint, the molding is long enough to accommodate that type of cut as well.

15 Using #4 finishing nails (Pneumatic nailer preferred), nail the cove molding to the interior walls.



16 Once the molding is secured to the walls nail it through the bottom & into the ceiling to help keep it in place.

Vent Valve and Vent Grill Installation

NOTE: One wall panel has a 4" x 6" opening in it for an air outlet vent. This panel is typically located on the back wall or toward the back of a side wall.

17 Slide the valve door open and place the opening directly over the 4" x 6" cutout. Making sure it is level, fasten it with two 1-1/2" screws (photo L).



18 From the outside of the sauna, center the wood grill over the exterior of the 4" x 6" cutout, with the louvers facing down. Making sure it is level, fasten with four 1-1/2" screws (photo M).

NOTE: If your back wall is hidden, the grill is not needed.

Bench Installation

In standard cases, the benches are positioned with the upper bench against the back wall of the sauna, and the lower bench parallel to it. There are four bench support boards: two that are 22-3/4" long for the upper bench, and two that are 46" long (length can vary with sauna model), for the lower bench. This extended length will allow the lower bench to slide under the top bench for ease in cleaning. Bench configuration will most likely be different with custom designed rooms.

NOTE: The interior walls have been marked at the heights you should attach the bench supports, generally top bench support at 30" and lower bench support at 12" off the floor. **These are the heights of the top edge of the bench supports, not the top of the benches!**



19 Position the bench supports about 1/4" away from the back walls. Making sure they are level, use 3" screws and pre-drilled holes to secure the bench supports to the walls (photo N). Be sure to install screws in all the pre-drilled holes. When installed at the height noted, the 3" screws will line up with the internal framing of the panels for necessary strength.

20 Install the benches, starting with the bottom bench first. Note that one side of the bench is finished, while the other has exposed framing. (This may vary with custom designed rooms). The bench should be installed with the finished face forward. Unless instructed otherwise, the benches do not need to be fastened to the walls. This will allow for ease in cleaning. However, if you desire no moveability of benches, fasten the benches directly to the wall using 3" screws through the 2x4 bench framework (the bench supports should still be used).

NOTE: Two 3/8" holes have been drilled through the frame of the upper L-bench. With the top of the benches aligned, use a 3/8" drill bit and drill through the 2 provided holes and through the face of the main upper bench. Bolt the two benches together using the 5-1/2" carriage bolts provided (photo O). Custom designed rooms may have a different bench configuration.

Backrest Installation

Some sauna models include backrests. Actual installation height will vary, depending upon the height of the sauna owner/user. Position it so the backrest is in the mid-back/shoulder blade area... whatever feels most comfortable. A standard height is 20" from top of bench to top of backrest.

21 Making sure it is level, hold the backrest at your preferred height, fasten it to the wall through the predrilled holes, using 2" screws (photo P). Wood plugs are provided to cover the exposed screw head.

22 Repeat step 25 if more than one backrest is included. Typically one backrest for each upper bench is included.

Exterior Facia Installation

NOTE: Do not install the facia until your heater is wired since the electrical access board may need to be removed.

23 The facia can be installed using simple butt-end cuts, or with mitre cuts. If using butt-end joints, cut the side wall facia the same length as the side walls (photo Q). Using the provided galvanized finishing nails, fasten with the top edge of the facia flush with the top edge of the ceiling panel. The front facia should be cut to overlap the side facia. Install flush with top of ceiling panel.

Heater Guard Installation

24 Place the heater guard around the heater as described in your heater instructions. Spacing may vary according to heater kilowatt.

NOTE: The front rails of the 2-sided heater guard can be cut to desired length before assembly.

Interior Light Installation

25 The light should be wired by a licensed electrician according to local codes. The light can be mounted on a wall of your choice. If you plan to use the corner lampshade, then the light will need to be installed tightly into a corner, 4" down from the cove molding (photo R). Otherwise, off to one side of the door is most common.

Sauna Heater Installation

26 The heater should be wired by a licensed electrician according to the specifications provided with the heater. One of the wall panels has a removable board to allow for wiring access to the heater (photo S). This tongue and groove board is located in the trim package. After the wiring is completed, attach the board with the galvanized nails provided in the hardware pack.

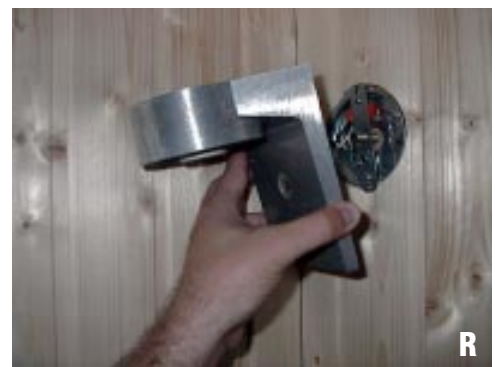
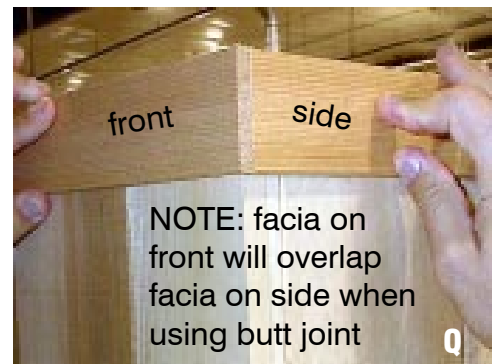
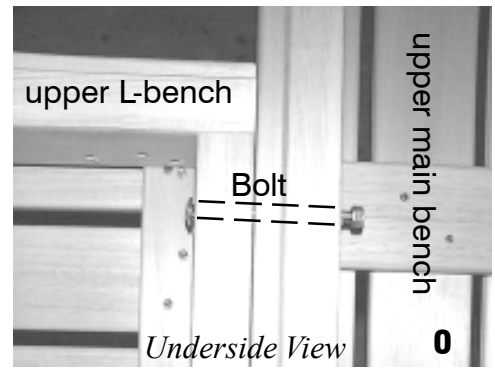

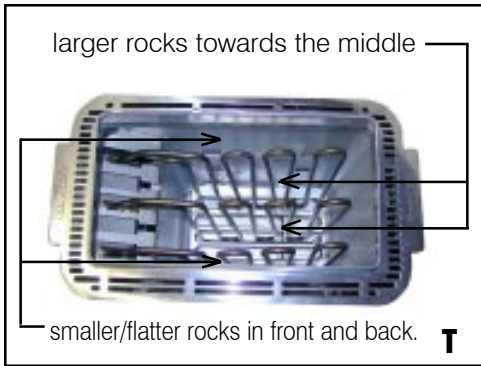

Rock Placement *(Very Important)*

27 Rinse the rocks before placing them in the sauna heater. Place the smaller and flatter rocks around the outside of the rock compartment and the larger rocks in the center (photo T). This will allow for good air transfer through the heater. Do not try to force all the rocks in, It is important to have space between the rocks to give optimum heater performance, faster heat-up time and higher temperatures. Save your extra rocks for replacements.



Door Handle Installation

A pair of door handles is provided with each door.

28 Using the screws provided, install the door handles with the center of the handle approximately 36" off the floor, or *whatever height is most comfortable* (photo U). After the handles are fastened, install the provided wood plugs to fill the holes.

Alta Addendum

Congratulations on the purchase of your new Alta Sauna. Because of its unique design some special assembly considerations are necessary. Please read your Modular/Panel Built Installation Instructions first and then refer to this addendum to assemble your room.

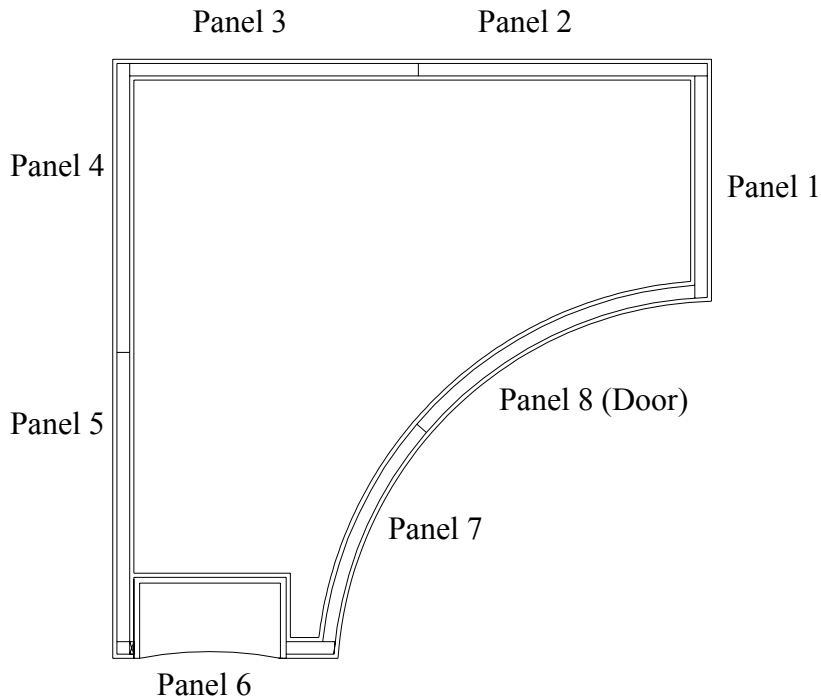

A. Layout your base frame on the floor noting how the front wall will make a gradual concave curve.

A. Start assembling your walls with panel 2 and continue around in numerical order till you reach panel 6 which contains your shelving unit.

B. Panel 6 is positioned so the shelves face outward.

C. Panels 7 & 8 are both concave curved. Place them on the base frame in the same way as the others and finish with panel 1.

D. On the top of panel 6 there is an extra cleat with 2 pre-drilled holes. Using 3" screws, fasten panel 6 to panel 5 by running the screws horizontally through the cleat and into panel 6.

E. Your top plate will have 2 curved sections. They are labeled and will be placed into position as shown by the photo.



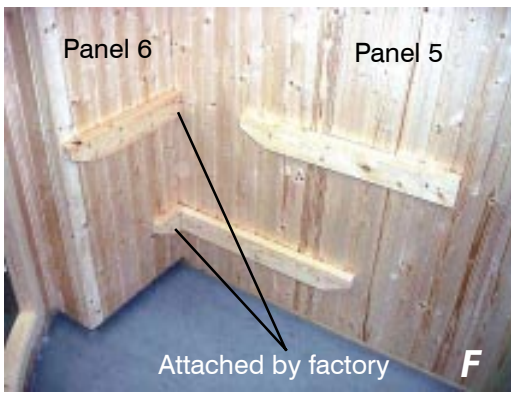

F. Notice that 2 bench supports have already been attached to the interior of panel 6. You will now need to attach both an upper and lower bench support to panel 5.

G. Use the pencil lines as a guide for positioning your bench supports.

NOTE: There are 5 bench supports you will need to attach. 4 of them are 24" long and the 5th is 19". The 19" support will be attached *after* your main lower bench is in place.

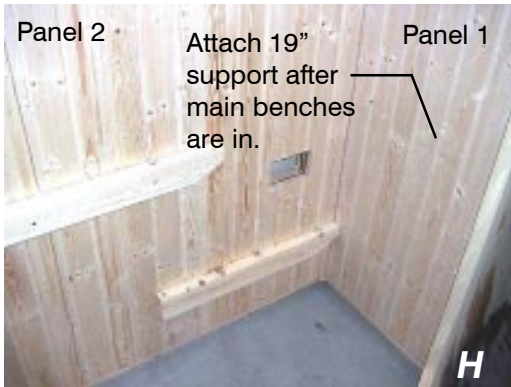

H. Attach 2 of the 24" bench supports to panel 2 leaving the 19" support for later or you will not be able to install your main lower bench.

I. Place your heater base into the back corner of the room



J. With the help of another person, place your heater on the base and tuck it as far into the corner as possible. It is OK for the heater to rest against the back 2 wall panels

K. Place your lower main bench on the lower bench supports.



L. Place your upper main bench on the bench supports and then install your 19" support on panel 1 (photo H).

M. Fasten your upper bench skirt to the walls using 2 screws on each side. **NOTE:** This bench skirt is not fastened to the upper bench frame like standard bench skirts.

N. Position your vent valve on the wall and fasten it.

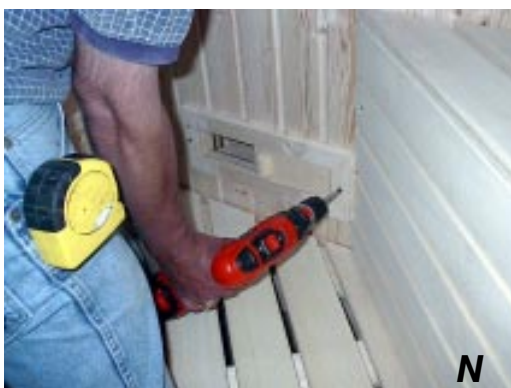

O. Put both your upper L-Benches in place and bolt them to the upper main bench.



P



CAUTION

Q

P. Making sure they are level, fasten your 4 backrests to the 4 walls. Mount your longest backrest first along panels 2 & 3 followed by your second longest on panels 4 & 5.



R



S

Q. The shortest of all 4 backrests will be mounted on panel 6. **NOTE:** When mounting this backrest use 1-1/4" screws instead of 2" to insure you do not run the screw through the face of the shelving unit. A sign has been placed on this wall panel to warn you of this.

R. With the help of one or more person, place your ceiling panel on the top of the room and fasten it.

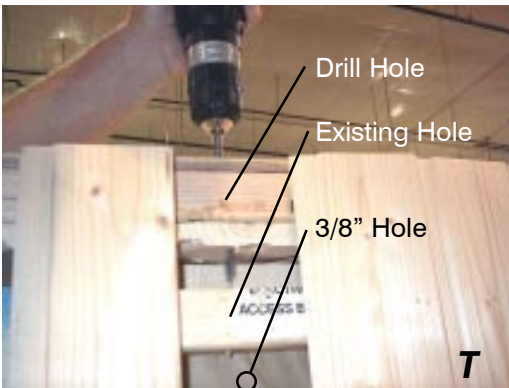

T



U

S. Note the electrical access on the back side of panel 4. On the corresponding piece of T&G on the interior of the room, measure down 5" from the ceiling and drill a 3/8" hole centered on this piece of T&G.

T. Drill a 3/8" hole through the ceiling. This hole should be aligned with the existing holes visible through your electrical access.



V



W

U. From the inside of the room feed the 2 valence lighting wires through the 3/8" hole, out the backside of the electrical access and up through the ceiling panel.

V. Fasten your light valence to panels 4 & 5 with its top about 3" from the ceiling.



X



Y

W. Mount your transformer to the top of the room and refer to its instructions for electrical connection.

X. Mount your 3 puck lights into the ceiling by simply pressing them into the holes.

Y. Install your 1" x 1/4" cove trim on both interior and exterior of your room where the walls meet the ceiling.

How To Enjoy Your Sauna

These instructions are intended as a general guide. If you have your own way to enjoy the sauna, we are sure you will be equally pleased with your purchase.

Close the vent on the back wall of the sauna. This will reduce the time taken for the sauna to reach the desired temperature.

Turn on the sauna heater. If the controls are built-in, the top knob is the timer which provides up to 60 minutes operating time. Allow 30-60 minutes heat-up time, plus plenty of time to enjoy the sauna. If more time is needed, simply reset the timer when it expires.

The bottom knob is the thermostat which determines the temperature of the sauna. Turn this knob about two thirds round the dial. Experience will show at which position the sauna reaches the heat which is most comfortable to you. Normal operating temperatures range from 160 to 175 degrees Fahrenheit taken at head-height.

If the controls external/separate from the heater, the timer is on the left, thermostat on the right.

Insure there is water in the sauna bucket. Use fresh tap water each time. Do not use spa or pool water with chemicals in it.

Wait for the sauna to reach the desired temperature (usually 30 to 60 minutes).

Take a warm shower and enter the sauna without drying. Open the sliding vent to ensure a good passage of air throughout the sauna. The ventilation system, with the vent positioned beneath the benches, prevents extreme variations in temperature between the upper and lower level benches, and it keeps heat loss to a minimum. Most importantly, it brings a continuous supply of fresh oxygen, making the sauna feel more open and comfortable.

Don't overdo it! Remain in the sauna long enough to warm up and stimulate a mild perspiration. Then take a shower to cleanse the skin; sit and cool down before reentering the sauna. Length of time in the sauna, and

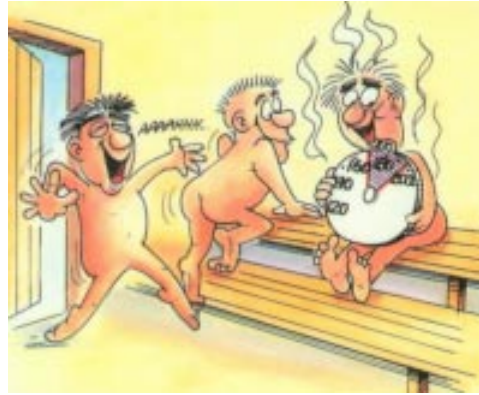

cool-off periods depend on your own comfort level. Reenter the sauna when you feel comfortable. This is the time when you completely relax. Have the temperature at a level which is comfortable for you; use water

from the sauna bucket to create steam. Ladle it on the rocks to adjust the humidity to your liking. With no water added, the humidity level in the sauna can be less than 10%. Most people prefer to add water, creating steam, to raise the humidity to the 20 to 25% range. Adjust to your liking.



When you are finished and ready to cool down, turn the sauna heater off by turning the thermostat off. If there is time left on the timer let it run itself out. Do not force the time to the OFF position!

Have another shower, cool enough to close your pores. Relax, enjoy the special "after sauna glow" enjoy an after-sauna snack of a healthful, cold drink, and something salty to eat. Enjoy the company of the friends you shared the sauna with, or any other non-strenuous pastime.

NOTICE: The timer on Built-in controls and separate controls has special features. Read this before operating!!

The timer has a 9-plus-1 feature. This allows you 60 minutes operation time, plus up to nine hours to preset delay. If you turn the timer into the 1-9 range, the heater will not operate. To operate the heater, turn the dial past the first section (zero to 1) or (Off to On) depending upon the heater or control, then turn back counterclockwise until you hear it click on. To use the preset time-delay feature, simply turn the dial to the number of hours you want to delay the start. For example, if you want the sauna to come on 4 hours later, turn the dial to 4. The time will wind down for 4 hours without the heater operating, then will click on and operate for one hour.