

THERMASOL

Cleanse Your Body. Purify Your Soul.

Installation Instructions

POWER PAK 230V

Commercial Steambath Generator

THREE PHASE

For machine of manufacture post May 2001

WARNING

- DO NOT USE THIS PRODUCT UNLESS YOU HAVE CONSULTED YOUR DOCTOR AND RECEIVED WRITTEN PERMISSION TO DO SO. USE OF THIS PRODUCT MAY BE HAZARDOUS TO YOUR HEALTH.
- STEAM IS HOT! DO NOT TOUCH OR GO NEAR THE STEAM HEAD FROM THE TIME THE UNIT IS "ON", UP TO ONE HOUR FROM THE TIME THE UNIT IS OFF. SEVERE BURN WILL OCCUR IF YOU COME IN CONTACT WITH THE STEAM HEAD OR STEAM EMITTING FROM THE STEAM HEAD.
- NEVER ATTEMPT TO FILL AROMA THERAPY RESERVOIR ON THE STEAM HEAD WHEN UNIT IS IN THE "ON" POSITION. SEVERE BURNS WILL OCCUR.
- DO NOT USE THERMASOL AROMA THERAPY OILS OR SKIN CARE PRODUCTS OR ANY PRODUCT IN CONJUNCTION WITH YOUR THERMASOL UNIT WITHOUT CONSULTING WITH YOUR ALLERGIST OR DOCTOR BEFORE USE. THESE PRODUCTS MAY BE HAZARDOUS TO YOUR HEALTH.
- YOUR SHOWER MAY BE A SLIP AND FALL HAZARD CHECK WITH YOUR CONTRACTOR OR TILE MANUFACTURER REGARDING THE SAFE USE OF YOUR FLOORING IN A STEAM APPLICATION. SLIPPING AND FALLING INTO THE STEAM HEAD ITSELF OR INTO THE STREAM OF STEAM EMITTING FROM THE STEAM HEAD WILL CAUSE SERIOUS BURNS, OR PHYSICAL INJURY.

Headquarters & Technical Support

2255 Union Place, Simi Valley, CA 93065 – (800) 776.0711

Sizing Your Steam room

Sizing: 1. Calculate the total volume of the enclosure. (Length x Width x Height = Total Volume).

2. Using the Volume total, multiply by the number to the right of your shower wall material shown below.

Example: 7 ft. long x 4 ft. wide 7 ft. high = 196 cubic feet
196 cubic ft. x 1.65 (marble) = 323.4 cubic ft. = Model #240 Steam Shower series generator.

NOTE: Add 10% for every foot exceeding 7 ft. in ceiling height.
Add 10% for every exterior outside wall.

▪ Fiberglass, Acrylic, Cultured Marble	.65
▪ Corian	No Change
▪ Ceramic tile on waterproof sheetrock, cement bed or mortar bed	No Change
▪ All glass tile, glass block walls	1.35
▪ Natural stone tiles 3/8" to 1/2" (marble, travertine, slate, granite, etc.)	1.65
▪ Natural stone tiles on cement bed or mortar bed	1.65
▪ Natural stone slab 3/4" to 1"	1.85

For further assistance call toll-free 800-776-0711

Generator Installation Instructions

Parts Enclosed

- Steam generator / built-in control
- Steam room sensor & 25 foot Lead wire
- Polished chrome steamhead

Materials Needed

- Brass ball valve
- Pipe compound
- Copper or brass nipples
(Size and quantities per Instructions)
- In-line filter (recommended)
- 3/8" brass or copper union
- Wire (sizes and quantities per Instructions)
- Copper tubing or pipe
- Wire cap nuts
- Flex conduit
- Brass or copper tee Connection & plug

Tools Needed

- Pipe wrench
- Tubing cutter
- Flaring tool (if flared fittings Are used)
- Pipe thread cap
- Wire cutters or wire strippers
- Adjustable wrench
- Screwdrivers (Philips & Regular)
- Solder & Flux
- 3/16" & 1.5" masonry drill bits
- Drill motor
- Propane Torch
- Other tools as required

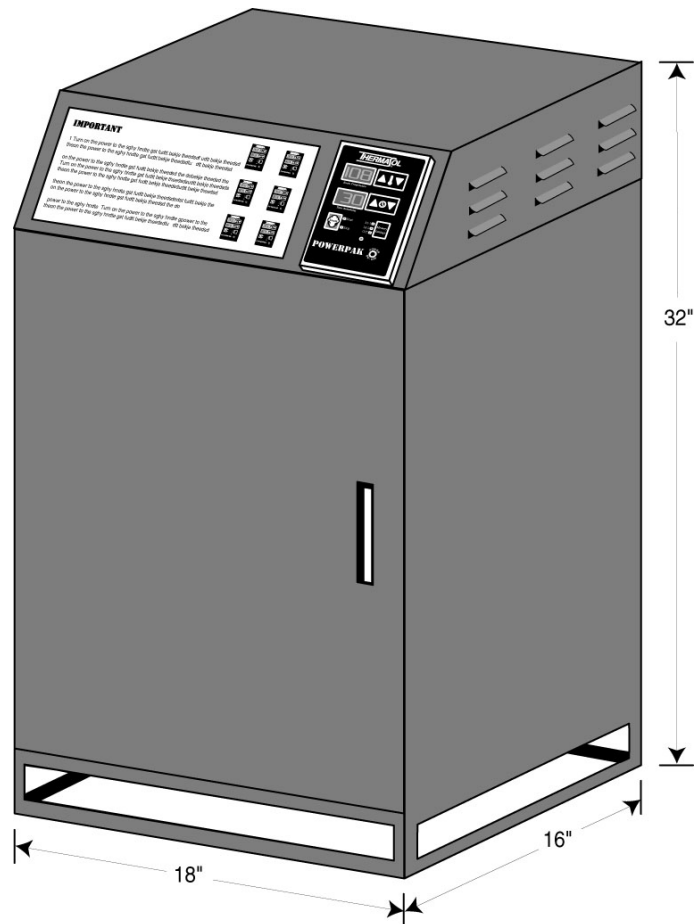

All Thermasol steam generators are designed to **Build NO PRESSURE** during operation. This Is for your safety.

NOTE:

Failure to follow instructions specifically Will cause warranty to be void.

Requirements for proper installation

1. Use copper or brass fittings only. **(NEVER USE GALVANIZED FITTINGS)**
2. The water inlet, steam outlet and pressure relief valve, need brass unions for easy removal.
3. The **generator must be upright, accessible and on a level surface** with **all** connections on the back. **Access panel on top and front must be unobstructed and allow for easy access.**
4. Unit may be installed up to 50 feet away from shower area.
5. **Do not** plumb a trap in the steam line or plumb the pressure relief valve into the steam line.
6. Pitch steam line back towards generator avoid **perfectly level plumbed lines.**
7. Before connecting water line to the generator, flush water line into a five-gallon pail to remove any silt or other materials that may be in the line. A Thermasol in-line water filter is recommended.

Caution: If the unit is run without water, serious damage may result! This possible damage is not covered under Thermasol's limited warranty.

Note: Failure to follow specific installation instructions will cause the warranty to be void.

Water Inlet

Refer to figure 1 for the following:

1. Connect tee to the hot or cold water line. Install copper pipe or tubing to the tee. If an in-line filter is to be installed on the water line to the generator, (which is suggested), it would be preferable to install the tee on the cold water line.
2. Install a brass shut-off valve on the water inlet line in an accessible area prior to the brass union and recommended in-line water filter.
3. Before making the last connection to the 3/8" water inlet line coming to the unit, flush the water line into a five-gallon pail to remove any silt or other materials that may be in the line.
4. Make the final connection and turn on water. All Thermasol generators are equipped with an automatic water fill system. The water will stop after unit is filled. **Make sure the power flush is in the closed position.**

IMPORTANT: MAXIMUM WATER PRESSURE 70 P.S.I.

Steamhead Installation

1. Drill a 1.5" diameter hole in the shower wall or wall for the steam outlet line. Refer to **figure 1a** as a guide for the proper location of the hole.

◆ **Caution: The steamhead is hot! And should not be located near a seat or bench!**

2. Connect 1" F.I.P. copper pipe or copper tubing and 1" brass union onto the steam outlet. Run a 1" copper pipe from the union to the 1.5" hole in wall. Install a 1" M.I.P. on the end of the 1" pipe for the steamhead.

3. Attach the steamhead and escutcheon to the copper pipe.

CAUTION: Do not obstruct the steam line with any shut-off valves, plugs or caps. ALL Thermasol steam generators are designed to build NO PRESSURE.

- ◆ The steam line can run up, down, or horizontal; but cannot run down and then up. If it does, a steam trap will be produced at the low point blocking the flow of steam. Insulate the steam outlet piping if the piping run exceeds 10 feet or is exposed to cold areas. **NOTE: Use steam rated insulation.**

NOTE: DO NOT mount sensor near steamhead!

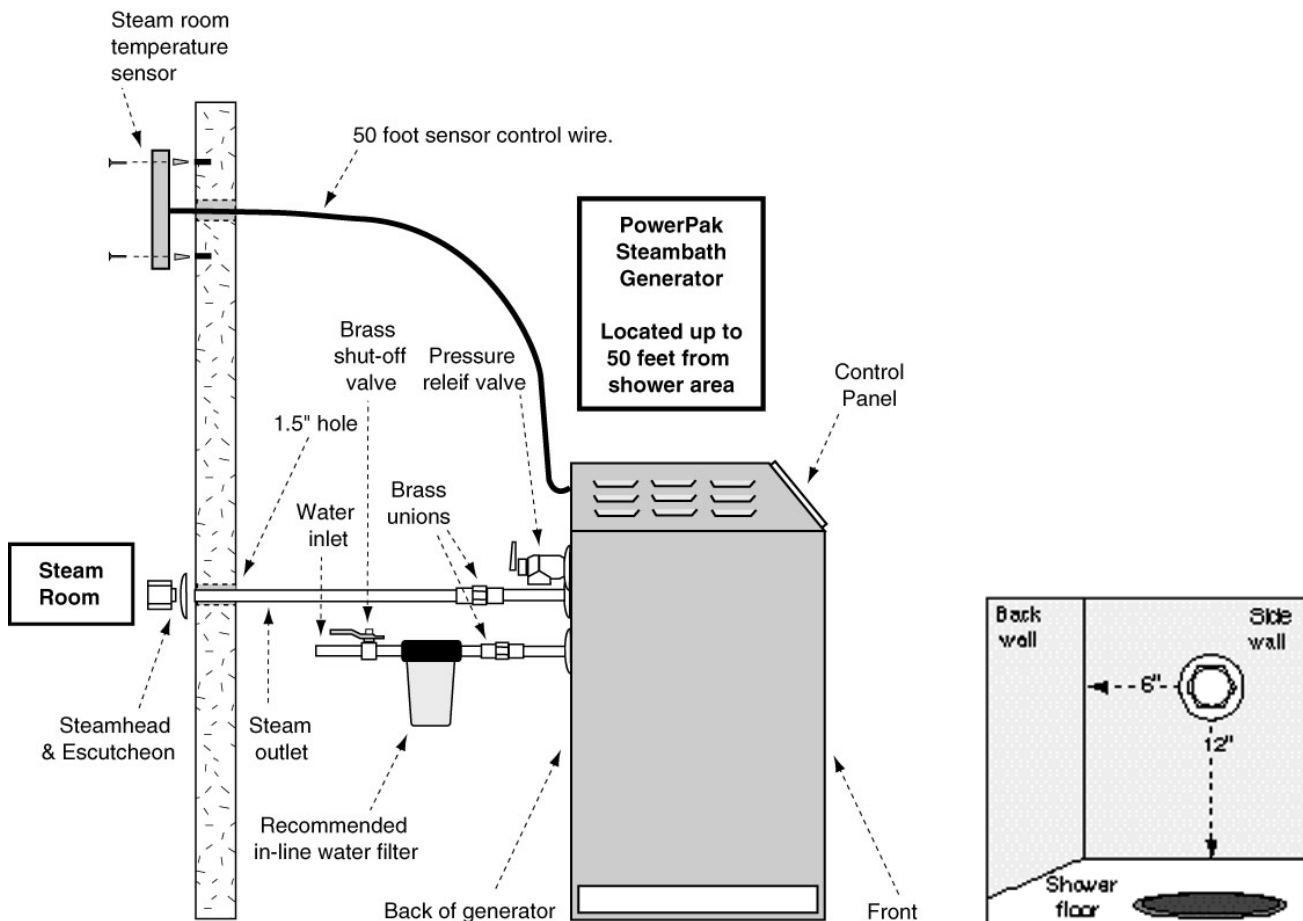

CONSUMER WARNING

WARNING

DO NOT USE THIS PRODUCT UNLESS YOU HAVE CONSULTED WITH YOUR DOCTOR AND RECEIVED WRITTEN PERMISSION TO DO SO. USE OF THIS PRODUCT MAY BE HAZARDOUS TO YOUR HEALTH.

WARNING

NEVER ATTEMPT TO FILL AROMA RESERVOIR ON THE STEAM HEAD WHEN UNIT IS IN THE ON POSITION. SEVERE BURNS WILL OCCUR.

WARNING

DO NOT USE THERMASOL AROMA THERAPY OILS OR SKIN CARE PRODUCTS OR ANY PRODUCT IN CONJUNCTION WITH YOUR THERMASOL UNIT WITHOUT CONSULTING WITH YOUR ALLERGIST OR DOCTOR BEFORE USE. THESE PRODUCTS MAY BE HAZARDOUS TO YOUR HEALTH.

WARNING

YOUR SHOWER MAY BE A SLIP AND FALL HAZARD CHECK WITH YOUR CONTRACTOR OR FLOORING MANUFACTURER REGARDING THE SAFE USE OF YOUR FLOORING IN A STEAM APPLICATION. SLIPPING AND FALLING INTO THE STEAM HEAD ITSELF OR INTO THE STREAM OF STEAM EMITTING FROM THE STEAM HEAD WILL CAUSE SERIOUS BURNS, OR PHYSICAL INJURY.

WARNING

STEAM IS HOT! DO NOT TOUCH OR GO NEAR THE STEAM HEAD FROM THE TIME THE UNIT IS "ON", UP TO ONE HOUR AFTER IT HAS SHUT OFF. SEVERE BURN WILL OCCUR IF YOU COME IN CONTACT WITH THE STEAM HEAD OR STEAM EMITTING FROM THE STEAM HEAD.

Electrical Instruction

NOTE: All electrical wiring must be done per local electrical codes.

Wire sizes recommended by National Electric code. Minimum wire temperature rating 90C.

Generator Model	Phase	Wire Gauge	Breaker Size	Fuse	Cubic Feet	kW
600	3	6	60	30A	600	18
900	3	6	70	40A	900	24
1200	3	4	90	50A	1200	30
1500	3	4	110	60A	1500	36

1. Turn off all electricity to the working area at the main breaker panel.
2. Connect **230-volt A.C.** electrical lines to wire labeled 1,2,and 3 in junction box on generator. (see figure 3)
3. Connect wires labeled 4, and 5 to the 60-min manual timer. Timer must be located outside of shower area.

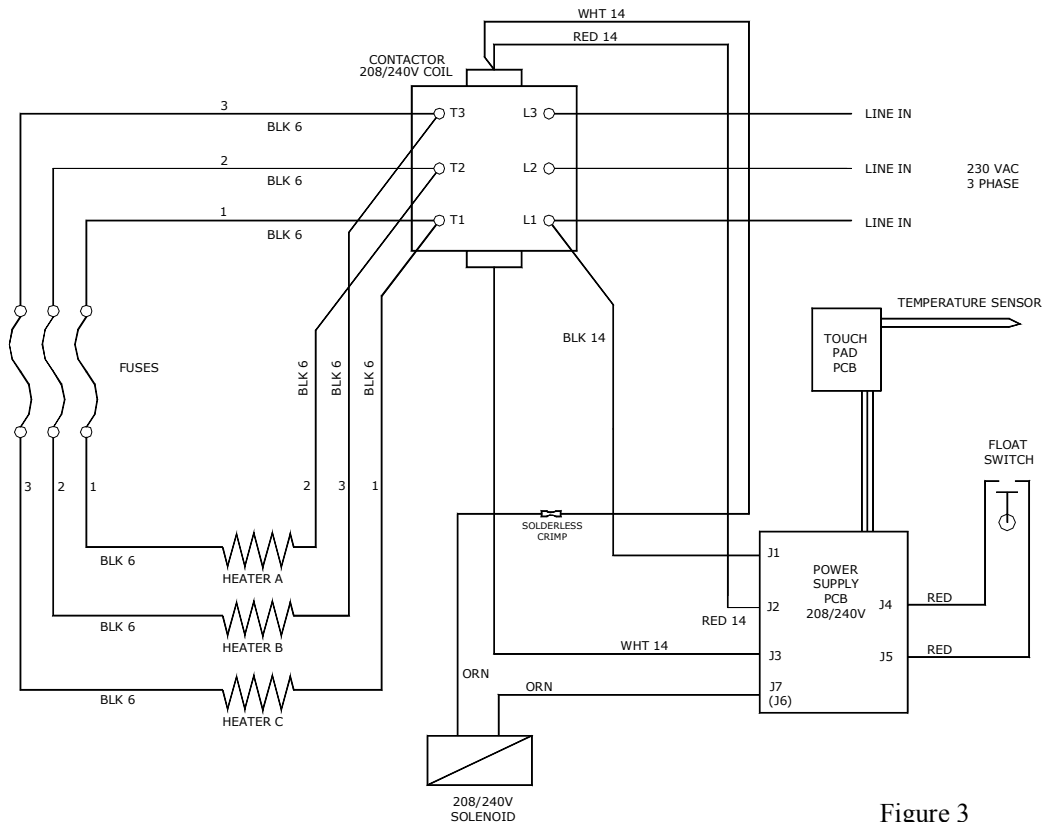

Figure 3

Instructions continue on page 6.

4. Connect 230 volt A.C. electrical lines to wired labeled L1 & L2 and L3 on the contactor.
See figure 3.
5. Install the temperature control sensor with bulb guard in the steam room approximately 5 feet above the floor. **See figure 1.**

NOTE: DO NOT mount sensor near steamhead!

6. Bring the control sensor wire to the generator. With the top cover removed, **see figure3**, connect the control sensor wires, using wire nuts, to the two loose wires on the back of the control panel.
7. Replace top access cover. Turn on both water and power to the generator.
8. Test the touch pad to ensure it is properly wired. If any technical problems arise, call toll free 800-776-0711.

Failure to follow installation instructions specifically may cause the warranty to be void!

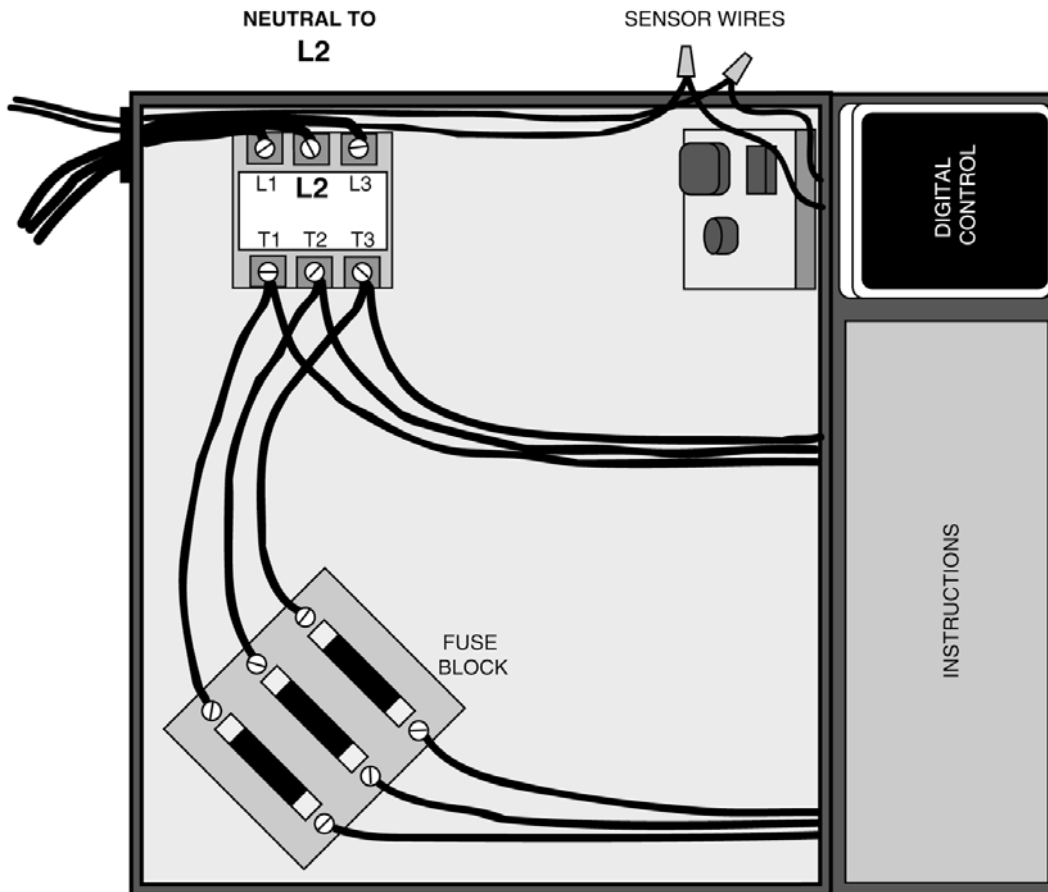

CONSUMER WARNING

WARNING

DO NOT USE THIS PRODUCT UNLESS YOU HAVE CONSULTED WITH YOUR DOCTOR AND RECEIVED WRITTEN PERMISSION TO DO SO. USE OF THIS PRODUCT MAY BE HAZARDOUS TO YOUR HEALTH.

WARNING

NEVER ATTEMPT TO FILL AROMA RESERVOIR ON THE STEAM HEAD WHEN UNIT IS IN THE ON POSITION. SEVERE BURNS WILL OCCUR.

WARNING

DO NOT USE THERMASOL AROMA THERAPY OILS OR SKIN CARE PRODUCTS OR ANY PRODUCT IN CONJUNCTION WITH YOUR THERMASOL UNIT WITHOUT CONSULTING WITH YOUR ALLERGIIST OR DOCTOR BEFORE USE. THESE PRODUCTS MAY BE HAZARDOUS TO YOUR HEALTH.

WARNING

YOUR SHOWER MAY BE A SLIP AND FALL HAZARD CHECK WITH YOUR CONTRACTOR OR FLOORING MANUFACTURER REGARDING THE SAFE USE OF YOUR FLOORING IN A STEAM APPLICATION. SLIPPING AND FALLING INTO THE STEAM HEAD ITSELF OR INTO THE STREAM OF STEAM EMITTING FROM THE STEAM HEAD WILL CAUSE SERIOUS BURNS, OR PHYSICAL INJURY.

WARNING

STEAM IS HOT! DO NOT TOUCH OR GO NEAR THE STEAM HEAD FROM THE TIME THE UNIT IS “ON”, UP TO ONE HOUR AFTER IT HAS SHUT OFF. SEVERE BURN WILL OCCUR IF YOU COME IN CONTACT WITH THE STEAM HEAD OR STEAM EMITTING FROM THE STEAM HEAD.

POWERPAK INSTRUCTIONS

1. After installation – turn on power to unit at the breaker. You will see a flashing dash and “12” in the upper window & “00” in the lower window.
2. First set the clock by pressing the “clock-start-stop” button once. You should see the light next to the “set clock” come on. Next, press the “day select” button until you reach the day you are at. The day is indicated on the left side of the upper window. (Monday = 1, Tuesday = 2, etc., etc.).
** (It is very important clock be set for the current day. If you are programming this unit on a Tuesday, then set the clock and day for Tuesday, day 2.) Using the arrows to the right of both windows set the current time in military time (24-hour clock). As an example 11:32 am would read 11 in the upper window and 32 in the lower window. 2:45 PM would read 14 in the upper window and 45 in the lower window.
3. Now you will set the “Steam Start Time”. Press the “Clock-Start-Stop” button once. You should see the light next to the “Start Time” come on and the light next to the “Steam” come on. Using the arrows set the time you want the steam to begin on that day from now onward. The day is “Select” button for each day and using the arrows to set the time you want the unit to begin steaming. Always end on the day you started with to ensure you have all the days programmed.
4. Next, set the “Steam Stop Time”. Press the “clock-Start-Stop” button once. You should see the light next to the “Stop Time” come on and the light next to the “Steam” remain on. Using the arrows set the time you want the steam to stop for that day from now onward. The day is indicated on the left side of the upper window. To program the rest of the week, press the “Day Select” button the day you started with to ensure you have all the days programmed.
5. Now you will set the Powerflush program. **** You must set the “Flush” time at least ½ hour past the “Steam Stop” time when no one is inside the steam room.** Press the “Clock-Start-Stop” button once. You should see the light next to the “Start Time” come on and the light next to the “flush” come on. Using the arrows, set the time you want the flush to start for that day from now press the “Day Select” button for each day and using the arrows to set the time you want the unit to begin its Powerflush. Always end on the day you started with to ensure you have all the days programmed. The Powerflush stops automatically at the end of its cycle. (Approximately 45 minutes).
6. Next set the temperature. Press the “Clock-Start-Stop” button once. You will see the day indicated now on the right side of the lower window and the desired temperature in the upper window. Using the arrows set the temperature you want for that day from now onward. The day is now indicated on the right side of the lower window. To program the rest of the week, press the “day Select” button for each day and using the arrows to set the temperature you want for that day. Always end on the day you started with to ensure you have all the days programmed.
7. It is now time to jump out of the program area. You are currently in the temperature setting mode. Make sure your day is correctly set. (Monday = 1, Tuesday = 2, etc., etc.). Remember, the day is now indicated on the right side of the lower window. Press the “Clock-Start-Stop” button once. This will take you out of the program mode and into the sleep (non-active) mode. A dash and the current time should be showing.

**** AFTER PROGRAMMING** To have the unit steam immediately, press the ON/OFF manual button once. You should see the “Steam” light flash continuously.**

TECHNICAL SUPPORT 800-776-0711

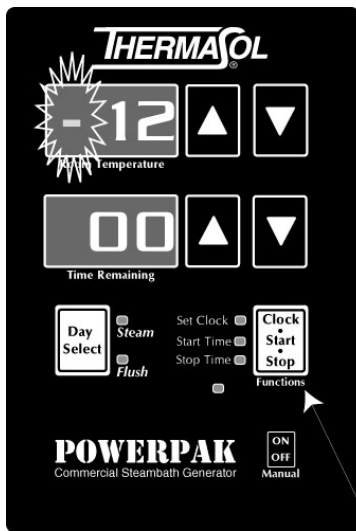

Figure A

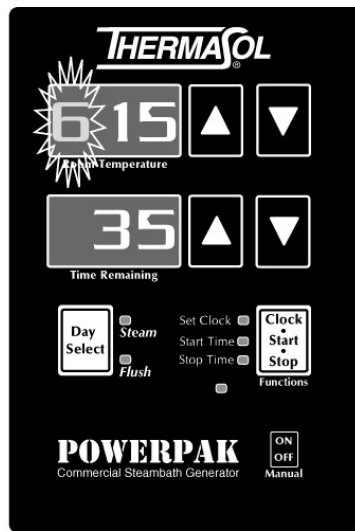

Figure B

Function Switch

Start time of 6:30 AM on Tuesday.

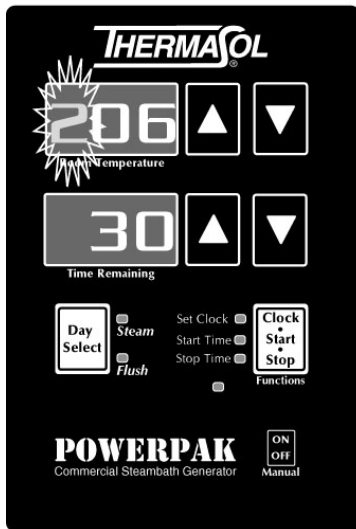

Figure C

Showing a 106 Degree temperature On Tuesday.

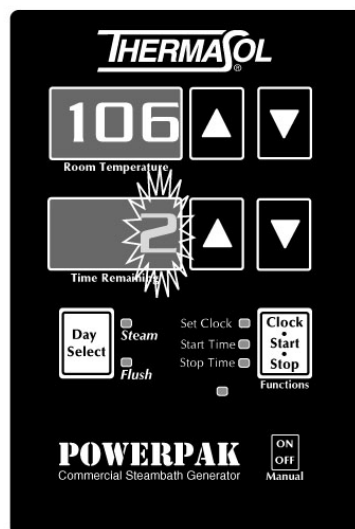

Figure D

Saturday at 3:35 PM, military time.

Power Flush

(True inner tank cleaning)

Steam Show generator demonstrating ThermaSol unique PowerFlush system.

Be sure no one is in the shower area during this cycle!

- ◆ Use of the Powerflush will vary according to local water conditions... speak with your plumber regarding conditions in your area.