



SPECIFICATIONS

Input Voltage.....	208-240VAC, 3-Phase
Kilowatt Rating.....	18.0Kw
Maximum Amperage.....	47 AMPS
Water Inlet.....	3/8" Compression
Steam Outlet.....	1.0" NPT
Drain Valve.....	3/4" GHT MALE
Safety Valve.....	3/4" NPT
Electrical connection.....	IEC 309
Maximum Room Size (cubic Feet).....	900

Commercial Superduty™ Series Standard Equipment:

- The only 100% networked digital technology in the industry (all other systems worldwide are old style analog).
- Neverdown™ option: standby backup units available
- SmartSteam™ - No irritating temp fluctuations - Perfect temp maintenance - Patented
- Wall Receptacle provided: IEC 309/ IP67/480V/60Amp
- Built in transport wheels
- Stainless 20" braided water flex/hose inlet connector
- Pre-plumbed 3/4" NPT pop-safety valve.
- Outside steam room 30 Minute Mechanical Timer included
- New style Polished Chrome steam head provided
- 1" union to connect to steam line
- Constant steam at a constant rate - no cycling.
- Can be plumbed 50 ft. from the shower without upsizing the generator.
- Superior heating elements – low watt density.
- Stainless steel construction throughout.
- 208-240 volt plug-in power cord (6 ft.)
- Split tank technology and large capacity enhances performance and life-span.
- Maximum of up to 100' distance from Master Controller to Generator. Cable is included.
- Hardware Kit
- Temp Sensor with a 50ft Lead wires is included

Installation Notes: Must be installed by licensed electrician. Install this generator according to the supplied installation guide. Follow local plumbing and electrical codes. Unit must be accessible. Generator is factory sized: L x W x H = Cubic Feet. Choose the appropriate generator. For every additional foot of ceiling height over 8 ft, use the next larger generator. Always round up when calculating the total cubic feet.

Product Specification Basics:

The steam generator unit dimensions shall approximately be 18-5/8" L x 21-1/2" W x 47-1/2" H in dimension. The generator shall be made from stainless steel and include: Smart Steam, PowerFlush, Split Tank, and use a 100% networked digital technology. Included is a Master Controller (not shown) that can be installed up to 100ft from generator. Hardware and Wall Receptacle is included along with stainless steel water connection hose.

Shipping Information:

Weight..... 328 lbs.
 Length.....18-5/8in.
 Width.....21-1/2 in.
 Height.....47-1/2in.

For any further assistance please contact ThermaSol at 800.776.0711 or sales@thermasol.com

Visit www.thermasol.com for a complete product definition

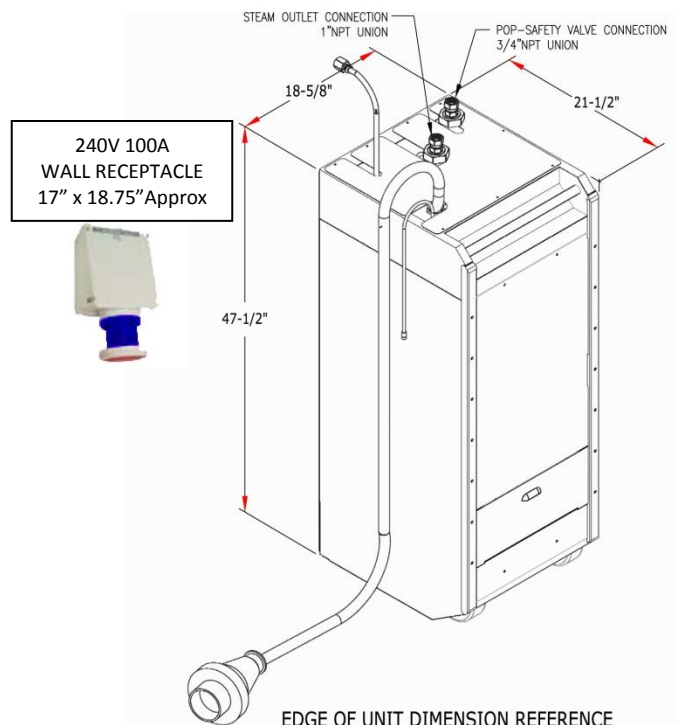

EDGE OF UNIT DIMENSION REFERENCE